



Special Features

- Wetted parts in acid-proof, stainless steel and PEEK
- Compact, food compatible, hygienic design
- Hygienic connections conform to 3-A standards, FDA demands and EHEDG guidelines
- Precise switching point without calibration
- Process temperature -40...200 °C
- Measures media with DC-values >1.5 (DC = Dielectric Constant)
- Not influenced by foam
- LED switch indicator
- Maintenance free
- Suitable for media separation measurement
- Configurable by FlexProgrammer 9701
- ATEX approval for gas and dust
- WHG approval (leakage and overflow)



Technical Data

Sensor

Radiated signal	100...180 MHz
Process connection	Hygienic: G1/2, 3-A/DN38 or sliding connection
Adapters	Refer to page 5
Insulating material	PEEK Natura

Mechanical data

Housing	Stainless Steel, W1.4301/AISI 304
Process connection	Stainless Steel, W1.4404/AISI 316 L
Amb. temperature	-40...85 °C
Process temperature	
Std. & 3-A/DN38	-40...115 °C (See curve 1)
Sliding connection	-40...200 °C (See curve 1)
< 1 hour, Tamb < 60 °C	-40...140 °C
Protection class	IP67 (IEC 529)
Media pressure (tested with water at 20°C)	Standard G½ hygienic < 10 bar 3-A DN38 < 40 bar Sliding connection < 16 bar
Vibrations	IEC 60068-2-6, GL test2
Installation	Any position

Electrical connection

Cable gland M16	Plastic, nickel-plated brass or stainless steel
Plug M12	Nickel-plated brass or stainless steel

Other electrical data

Power supply	12,5...36 VDC, 35 mA max.
Damping	0...10 sec.
Power-up time	<2 sec.
Hysteresis	± 1 mm
Repeatability	± 1 mm
Reaction time	0.1 sec. (100 ms)

Approvals/conformities

Approvals/conformities	EN 1935/2004, EN 10/2011, EN 2023/2006, EN 50155 Railway, 3-A, EHEDG, FDA, WHG (leakage and overflow) UL listed, E36692
------------------------	---

Disposal of product and packing

According to national laws or by returning to Baumer.

EMC data

Immunity	EN 61326
Emission	EN 61326

Ex data (ia)

Internal inductivity	$L_i \leq 10 \mu\text{H}$
Internal capacity	$C_i \leq 33 \text{ nF}$
Barrier data	$U \leq 30 \text{ VDC}$; $I \leq 0.1 \text{ A}$; $P \leq 0.75 \text{ W}$

Approval Ex ia IIC T5, ATEX II 1G (See table 1)

Supply range	24...30 VDC
Temperature class	T1...T5: -40 < T _{amb} < 85 °C

Approval Ex tD A20 IP67 T100 °C, ATEX II 1D (See table 1)

Supply range	12,5...30 VDC
Temperature class	T100 °C: -40 < T _{amb} < 85 °C

Approval Ex nA II T5, ATEX II 3G (See table 1)

Supply range	12,5...30 VDC
Temperature class	T1...T5: -40 < T _{amb} < 85 °C

Output

Output (active)	Max. 50 mA, short-circuit and high-temperature protected
Output type	PNP, NPN or Digital output (Push-pull)
Output polarity	See drawing
Active "Low"	NPN and Digital output (-VDC +2.5V) ± 0.5V ; Rload 1 kOhm
Active "High"	PNP and Digital output (VDC -2.5V) ± 0.5V ; Rload 1 kOhm
Off leak current	± 100 µA Max.

Technical Data

Factory Settings

Output	PNP
Measure	DC value >1.5
Damping	0.1 sec.

Dimensional Drawings

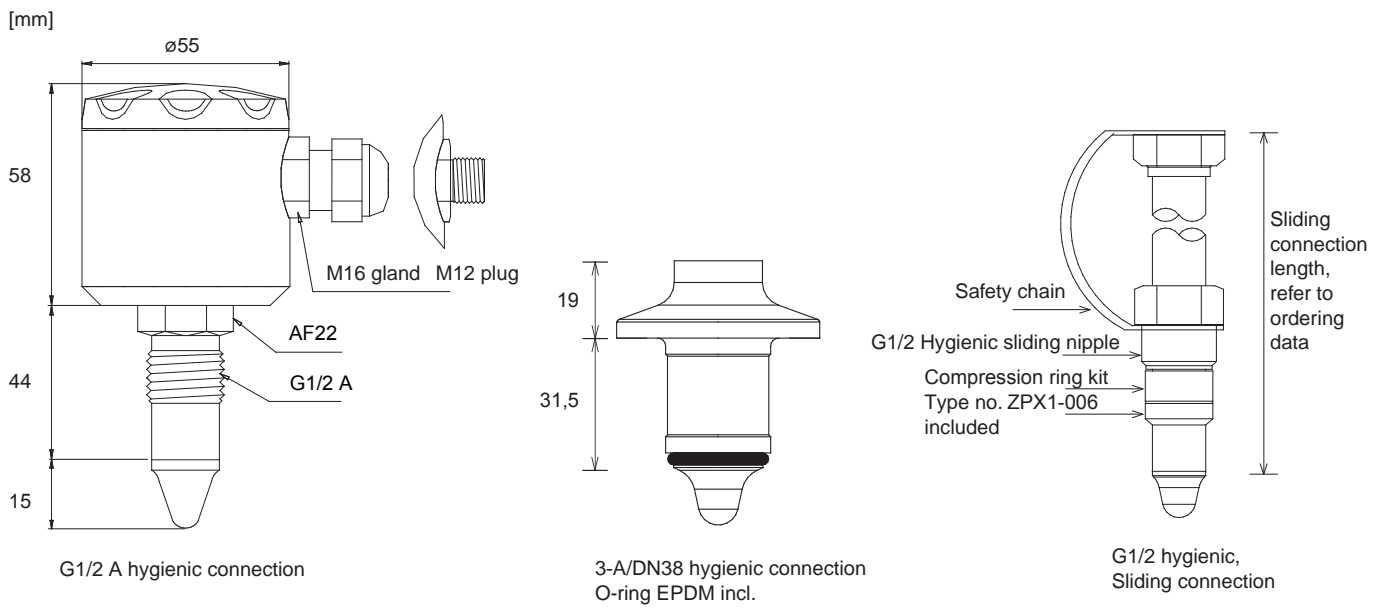

Sliding connection load

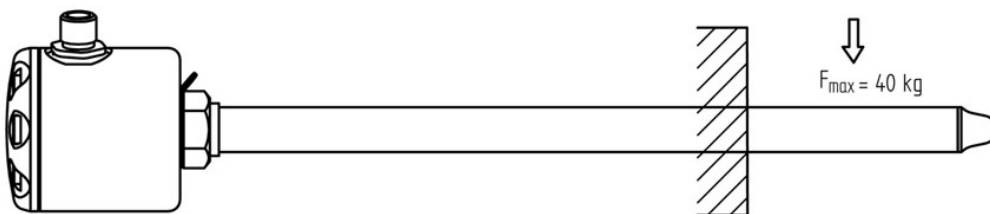

Electrical Connection

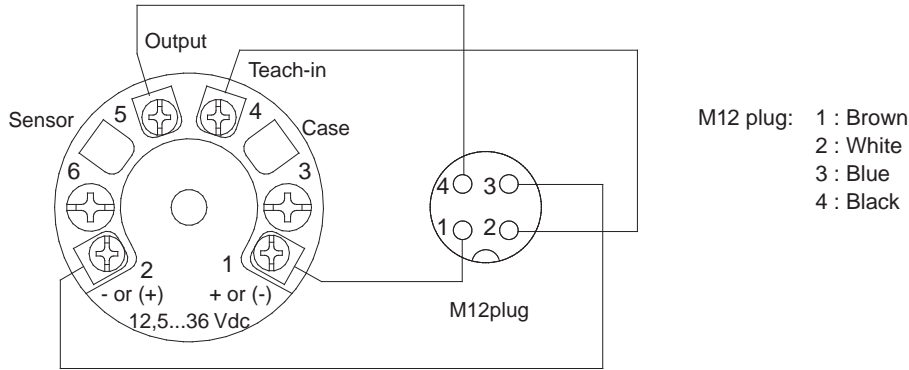

Electrical Installation

Normally Open

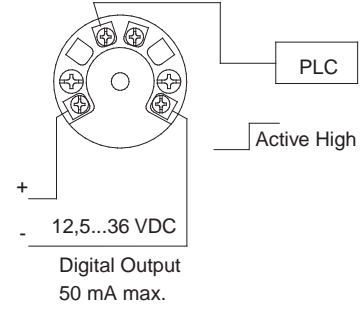
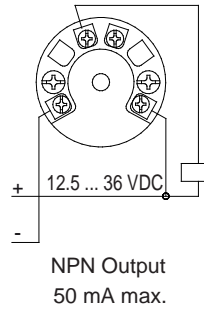
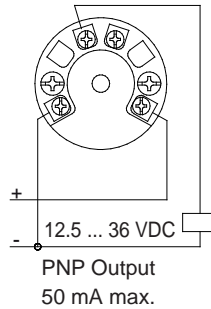
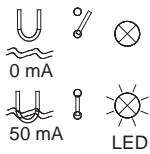

Normally Closed

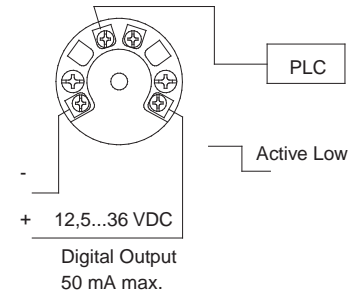
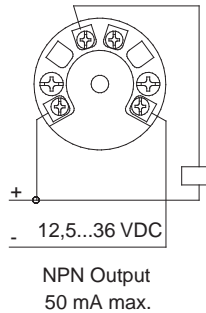
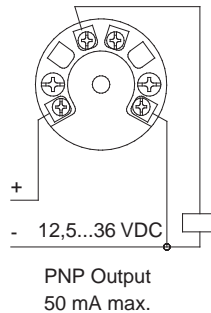
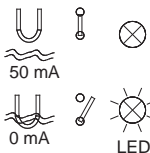

Configuration

FlexProgrammer 9701

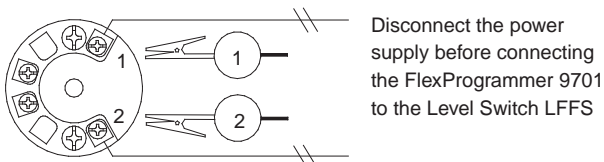
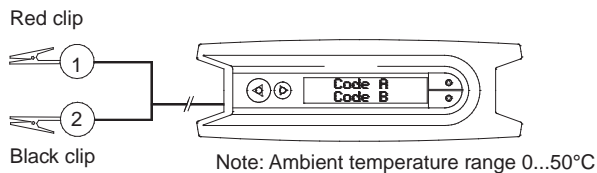

Accessories



The FlexProgrammer 9701 is a dedicated tool to configure all Baumer configurable Flex-products.

Type No. 9701-0001 comprises:
FlexProgrammer
Cables
CD with the FlexProgram software

The Sliding Connection (Figure 1)

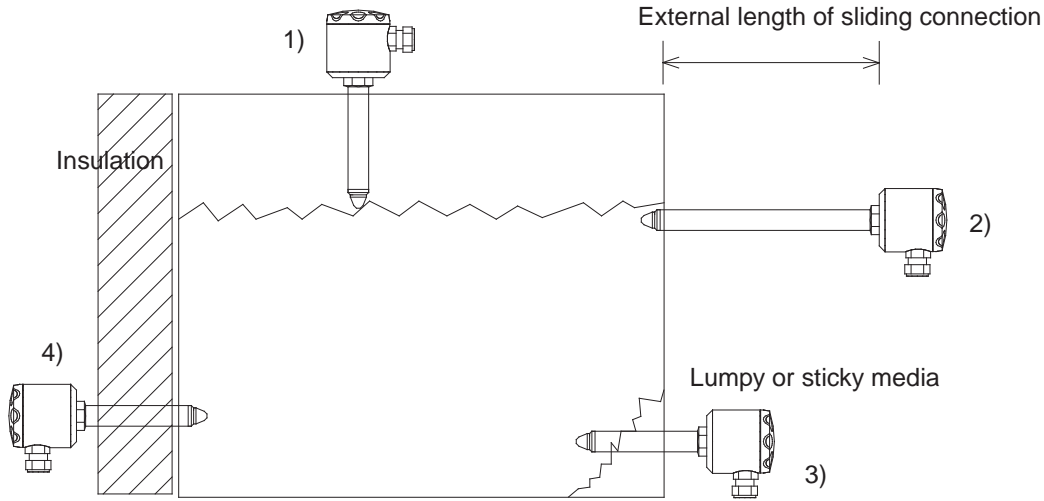

The drawing shows how the sliding connection can be used for at least 4 applications:

- 1) Mounted at the top of a tank to adjust to a maximum level.
- 2) Serving as a cooling neck in high media temperature applications.
- 3) Adjusted to place the sensor tip deeper inside the tank.
- 4) To reach in through insulation material.

It is essential that the max. ambience temperature for the electronics is never exceeded. For ATEX approved products please refer to table 1.

The working conditions for the sliding connection in different media temperatures and specified ambient temperatures can be found in curve 1.

Example, how to read Curve 1:

A 250 mm sliding connection is mounted in a tank with a total insert length of 150 mm. Hence the external length of the sliding connection will be $250 - 150 = 100$ mm.

The media temperature will be max. 160°C .

Read the x-axis at 100 mm on the y-axis at 160°C and find that the ambient temperature must be kept below 50°C . In case the radiated heat from the tank will cause a higher ambient temperature at the housing efficient insulation of the tank must be established

Media Temperature versus External Length of Sliding Connection (Curve 1)

Media Temperature
 $^{\circ}\text{C}$

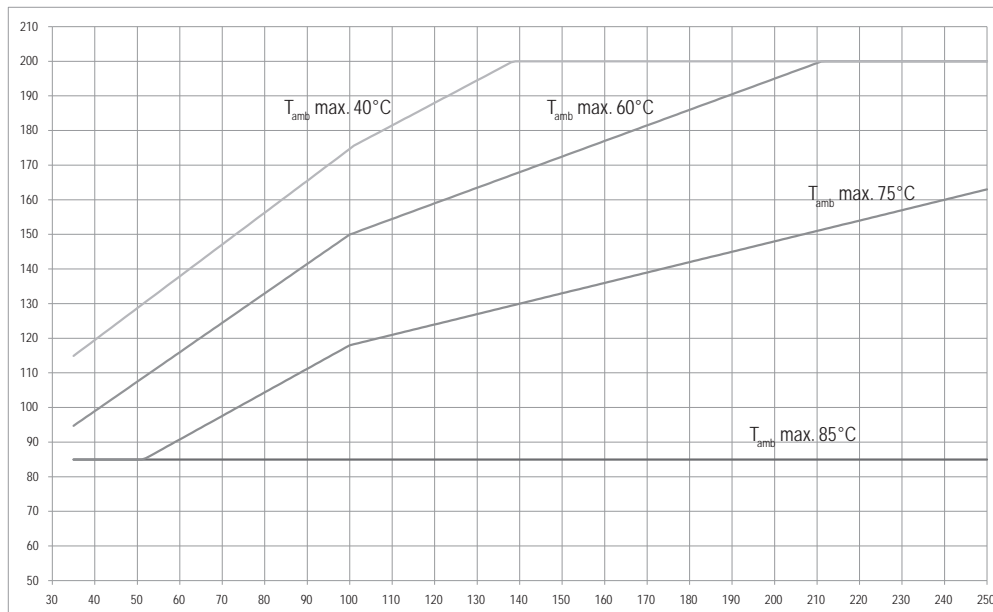

External length of sliding connection (mm) See figure 1

NB: Std. + 3A/DN38 = 35 mm external length

Accessories - Overview

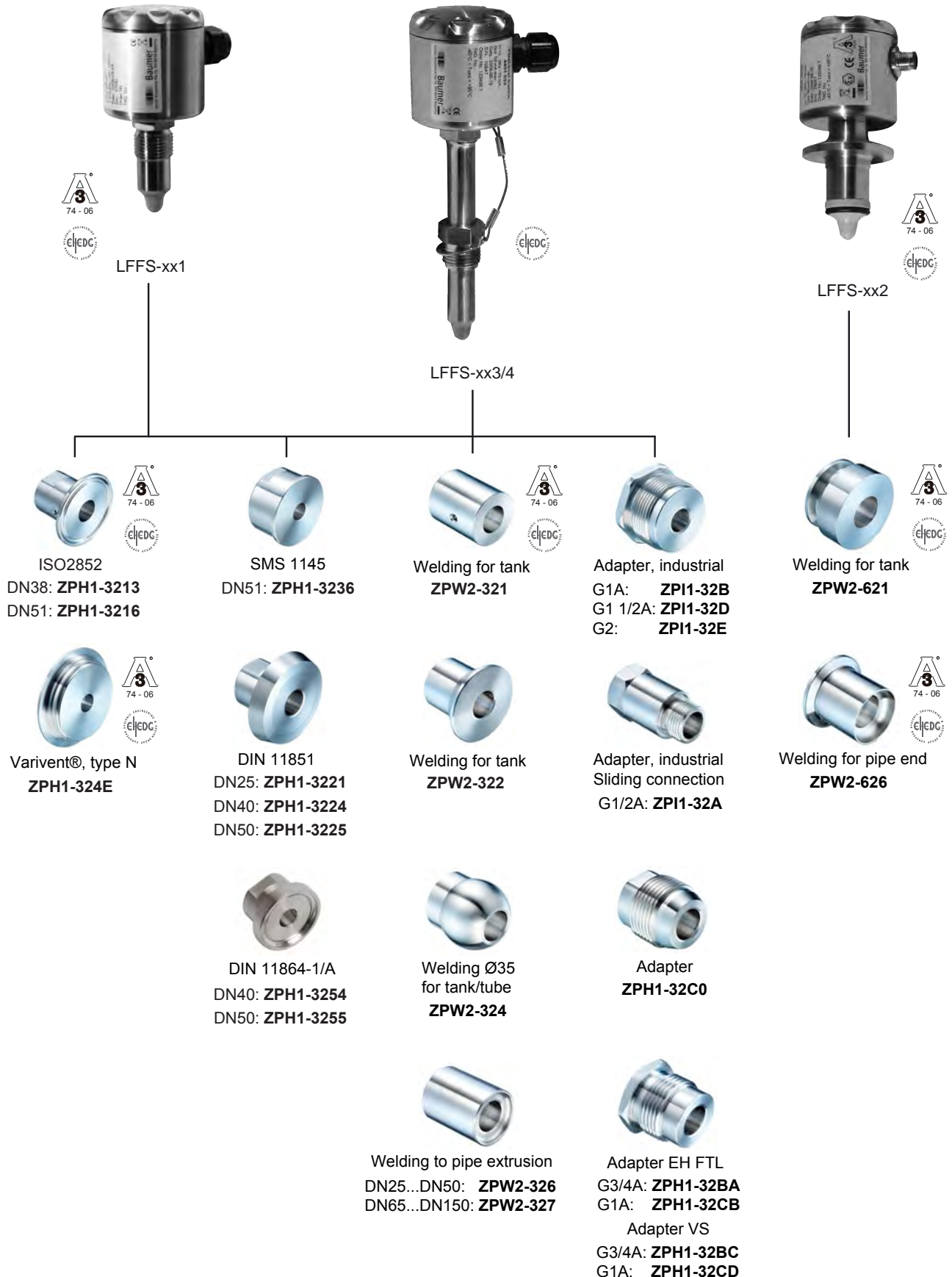

Ex ia G - Installation

A Level Switch LFFS-1xx is Ex ia IIC T5, ATEX II 1G approved for application in hasardous areas in accordance with the current EU directives. The product must be installed in accordance with prevailing guidelines for zone 0 with a barrier.

Ex tD - Installation

A Level Switch LFFS-2xx is Ex tD A20 IP67 T100°C, ATEX II 1D approved for application in hasardous areas in accordance with the current EU-directives. The product must be installed in accordance with prevailing guidelines for zone 20 without a barrier.

Ex ia G, Ex nA G - Installation

A Level Switch LFFS-3xx is Ex nA II T5, ATEX II 3G approved for application in hasardous areas in accordance with the current EU-directives. The product must be installed in accordance with prevailing guidelines for zone 2 without a barrier.

Ex ia IIC T5, ATEX II 1G - Installation

A Level Switch LFFS-1xx is Ex ia IIC T5, ATEX II 1G approved for application in hasardous areas in accordance with the current EU directives. The product must be installed in accordance with prevailing guidelines for zone 0 with a barrier.

A certified Ex ia or isolation barrier with the maximum values $U_{max} = 30$ VDC ; $I_{max} = 0.1$ A ; $P_{max} = 0.75$ W must be used.

Conditions for Ex-Certification (Table 1)

Connection Type	Tamb °C	Media Temp. max. °C	Note
Std. & 3-A/DN38	-40...85	85	
	-40...60	95	{2}
	-40...40	115	{2}
Sliding 100 mm	-40...85	85	
	-40...60	150	{2}
	-40...40	175	{2}
Sliding 250 mm	-40...85	85	
	-40...60	195	{2}
	-40...40	200	{2} {3}

Note {2}: Provided that the sensor tip at the instrument is the only part in contact with the media.

Note {3}: Max. allowed media temperature.

Ex-data

Supply range	24...30 VDC
Temperature class	T1...T5: See table 1
Internal inductivity	$L_i < 10 \mu\text{H}$
Internal capacity	$C_i < 33 \text{ nF}$
Barrier data	$U < 30$ VDC ; $I < 0.1$ A ; $P < 0.75$ W

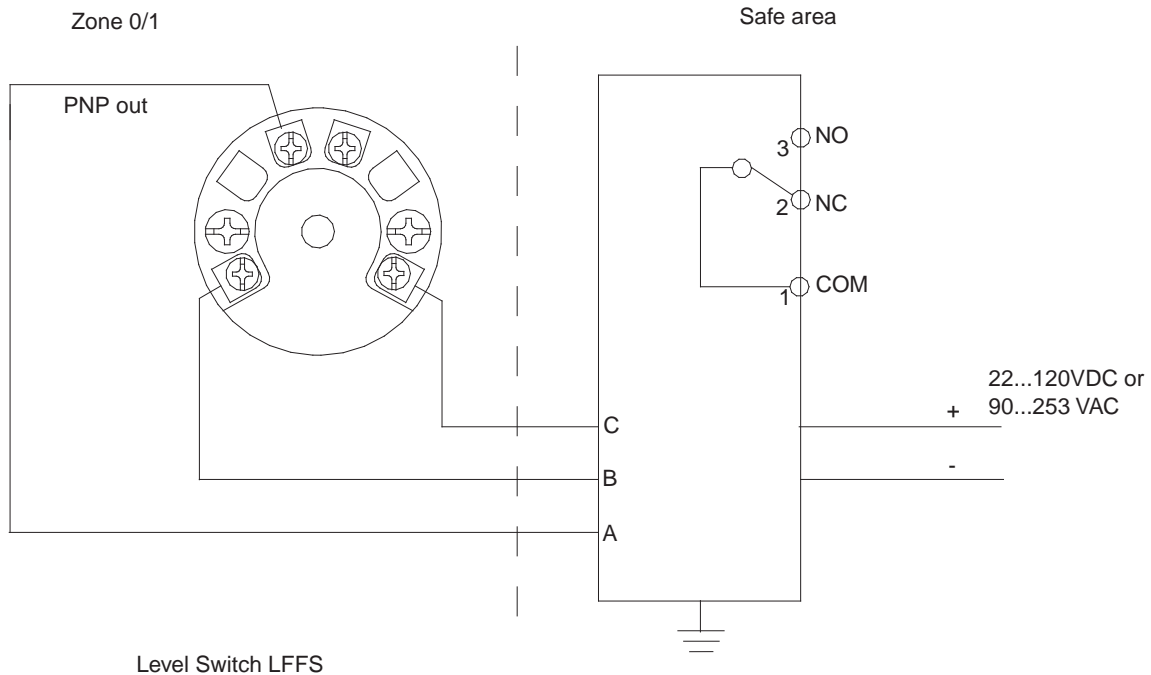

NB: For PNP output the PROFSI3-B25100-ALG-LS barrier must be used.

Isolating Module
PROFSI3-B25100-ALG-LS

Ex tD A20 IP67 T100, ATEX II 1D - Installation

A Level Switch LFFS-2xx is Ex tD A20 IP67 T100°C, ATEX II 1D approved for application in hasardous areas in accordance with the current EU-directives. The product must be installed in accordance with prevailing guidelines for zone 20 without a barrier.

Ex-data

Supply range	12,5...30 VDC, max 100 mA
Temperature class	T100: See table 1

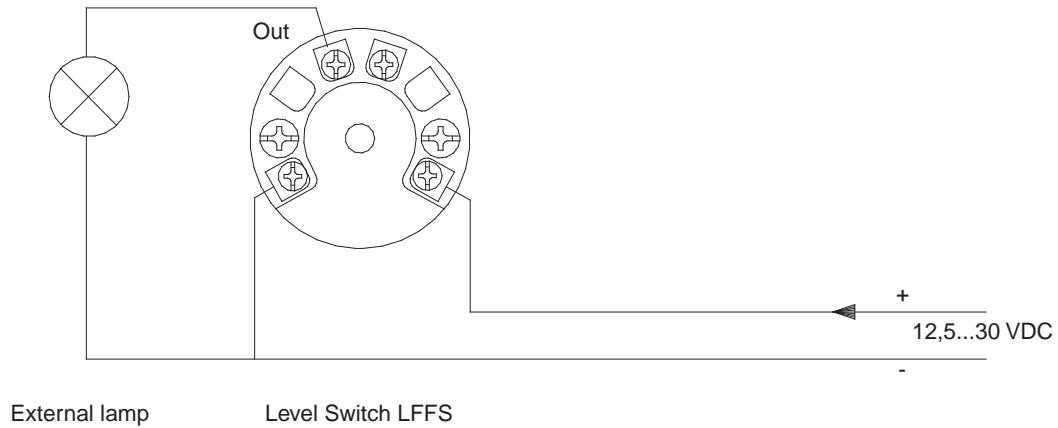

Ex nA II T5, ATEX II 3G - Installation

A Level Switch LFFS-3xx is Ex nA II T5, ATEX II 3G approved for application in hasardous areas in accordance with the current EU-directives.

The product must be installed in accordance with prevailing guidelines for zone 2 with a barrier.

Ex-data

Supply range	12,5...30 VDC, Max. 0.1A
Temperature class	T1...T5: See table 1

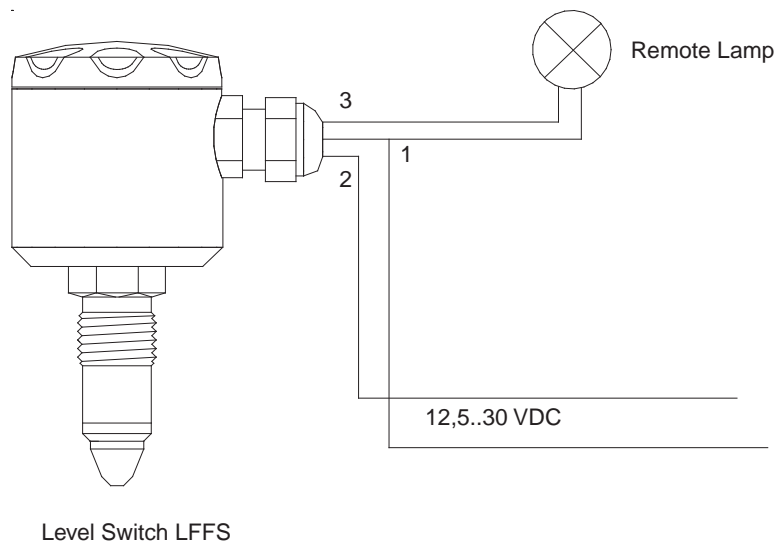

Ordering details

		-	.
Model		LFFS	
Level Switch			
Safety	5' digit		
Standard		0	
Ex ia IIC T5, ATEX II 1G (Gas) *		1	
Ex tD A20 IP67 T100 °C, ATEX II 1D (Dust)		2	
Ex nA II T5, ATEX II 3G		3	
UL listed, E365692		A	
Electrical Connection	6' digit		
M12, 4 pins, nickel-plated brass		1	
M16 cable gland, nickel-plated brass		2	
M16 cable gland, polyamide		3	
M12, 4 pins, stainless steel		4	
M16 cable gland, stainless steel		5	
Process connection	7' digit		
G1/2 A, PEEK tip ⁽¹⁾		1	
3-A/DN38 Hygienic connection ⁽¹⁾		2	
G1/2, PEEK tip, sliding connection, 100 mm adjustable, incl. compression ring kit ZPX1-006 ⁽²⁾		3	
G1/2, PEEK tip, sliding connection, 250 mm adjustable, incl. compression ring kit ZPX1-006 ⁽²⁾		4	
Configuration	8' digit		
No configuration			0
Configuring according to customer specification			C

* For PNP output the barrier module PROFSI3-B25100-ALG-LS is required for functional purposes.

The compression ring kit for sliding connection, type no. ZPX1-006 can be ordered separately.
Baumer recommended to replace this kit if deformed.

3-A certificate / EHEDG certificate

⁽¹⁾ The 3-A mark and the EHEDG certificate is valid only when the product is mounted in a 3-A marked or EHEDG certified counter part and installed according to the installation manual. Use also a 3-A marked O-ring or gasket if relevant. The 3-A marked products conforms to the 3-A Sanitary Standard criteria. Materials and surfaces fulfill the FDA demands and are certified by EHEDG.

⁽²⁾ Certified by EHEDG. Fulfills the FDA demand.
EPDM O-rings supplied with 3-A marked products are conform to Sanitary Standard Class II (8% milk fat max.)
EPDM gaskets supplied with 3-A marked products are conform to Sanitary Standard Class I (8% milk fat max.)
Refer to the 3-A marked counter parts in the data sheet "Process connections & accessories".

Level Switch LFFS, example

